

# 1250 GALLON GREASE INTERCEPTOR

## STANDARD FEATURES:

- 5000 PSI CONCRETE
- GRADE 60 REINFORCING
- 8" TRAFFIC BEARING LID
- AASHTO H-20 RATED
- 4" WALLS AND FLOOR
- 2 COMPARTMENTS STANDARD

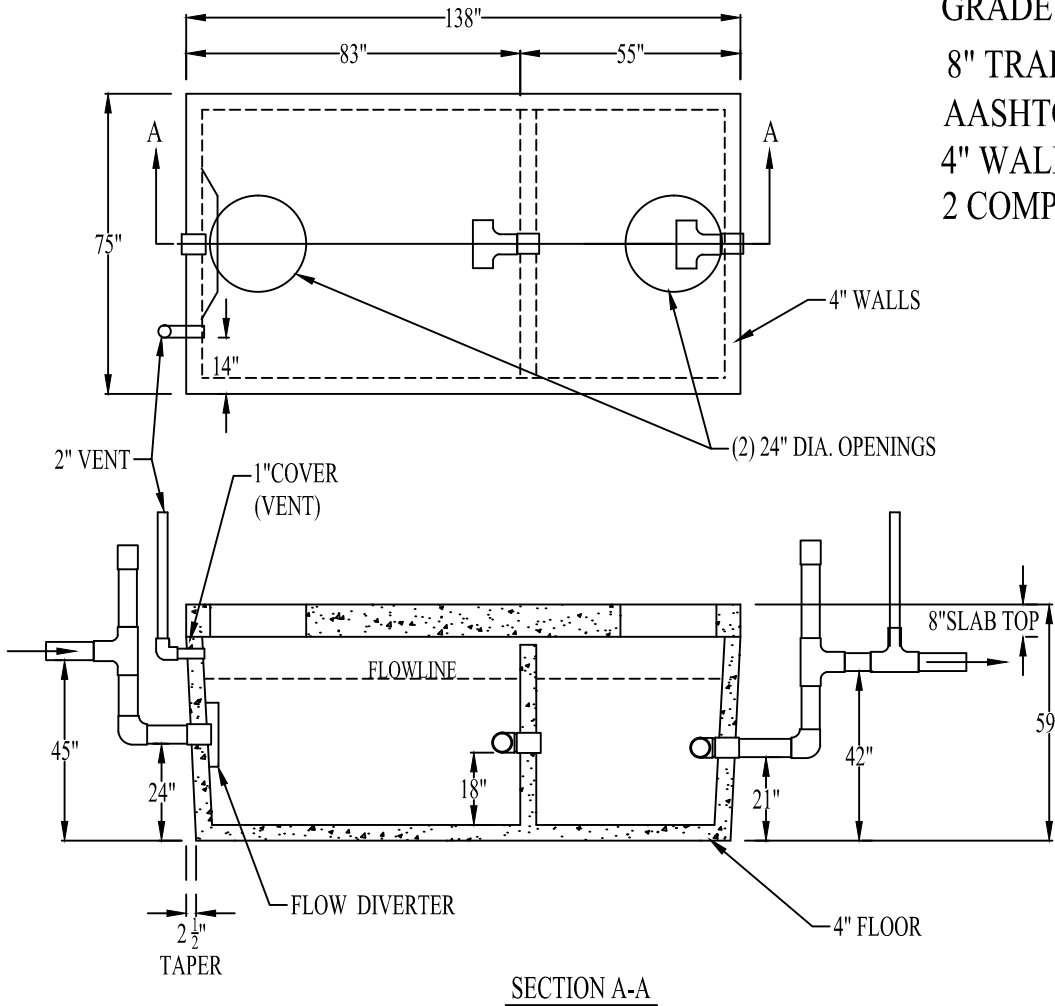

## NOTES:

- ALLOW FOR MANHOLE AND COVER IN TOTAL HEIGHT.
- STANDARD INLET/OUTLET FITTINGS ARE 4" BOOT (6" AVAILABLE)



CAPITAL PRECAST, INC.

6905 SOUTH OLD BASTROP HWY  
 SAN MARCOS, TEXAS 78666  
 PH. (830) 606-6200

FOR 1250 Grease Interceptor

JOB

DRAWN DK DATE 11/21/17 Rev. No. 05/17/18 03/24/20

FILE RemovableDisk(H:)/1250GI.dwg