

City of San Antonio 5' Curb Inlet with Variable Invert

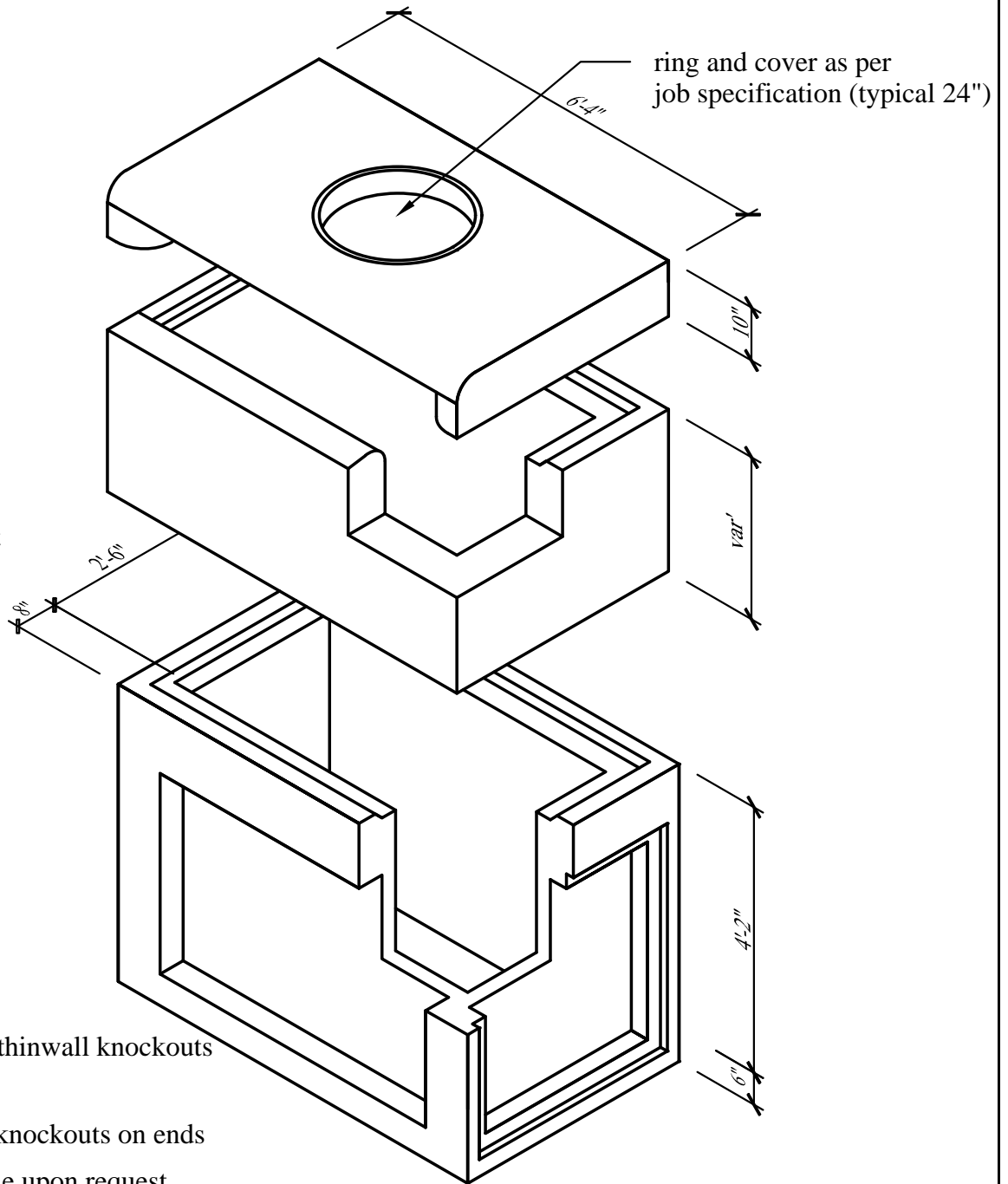

Approximate weight
of base: 7,400 lbs
at 4'-2" height

Bottom Section:

- 48" x 36" rectangular thinwall knockouts on front and rear
- 34" x 36" rectangular knockouts on ends
- Riser sections available upon request
- Concrete has a 28 day strength of 5,000 psi
- Steel reinforcement is ASTM A615 grade 60
- Load design is H-20

Notes:

- Consult manufacturer before handling



CAPITAL PRECAST, INC.

6905 SOUTH OLD BASTROP HWY
SAN MARCOS, TEXAS 78666
PH. (830) 606-6200

FOR 5' Curb Inlet with Variable Invert - San Antonio

JOB

DRAWN

RW

DATE

12/1/2015

Rev. No.

SHEET

FILE

catalog/curbinlets/5' curb SA variable

1 OF 1