

# 3' x 5' x var Junction Box

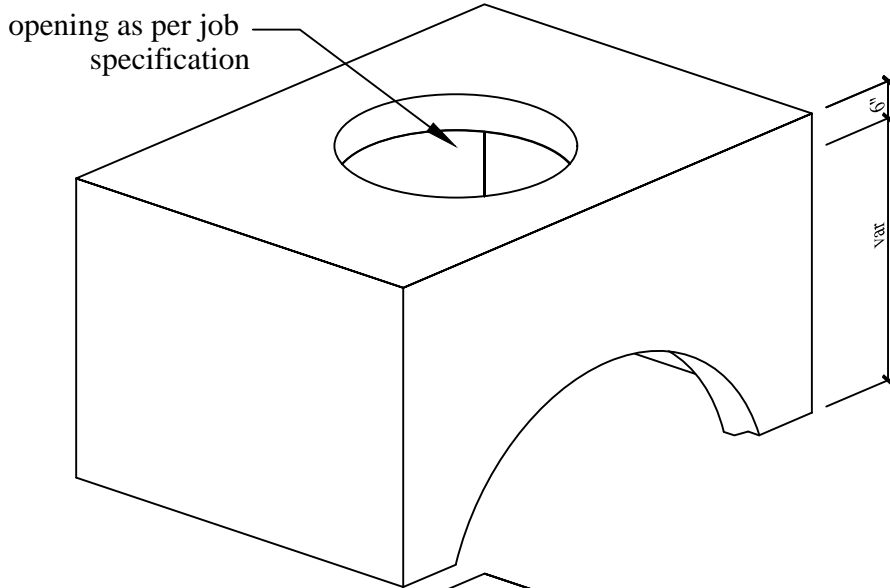

Bottom Section  
knockouts as requested

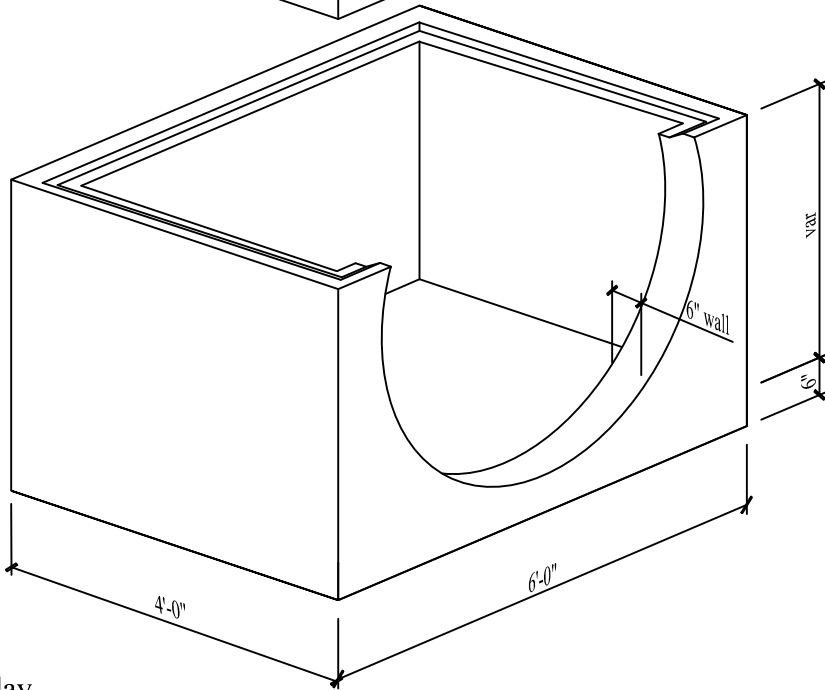

Approximate weight  
of base: 6,000 lbs  
at 3'-0" height

**Specifications:**

- Concrete has a 28 day strength of 5,000 psi
- Steel reinforcement is ASTM A615 grade 60
- Load design is H-20

**Notes:**

- Consult manufacturer before handling



**CAPITAL PRECAST, INC.**

6905 SOUTH OLD BASTROP HWY  
SAN MARCOS, TEXAS 78666  
PH. (830) 606-6200

FOR 3' x 5' x var Junction Box

JOB

DRAWN

RW

DATE

12/1/2015

Rev. No.

SHEET

FILE

catalog/junction boxes/3x5JB

1 OF 1