

30" x 30" x var Grate Inlet

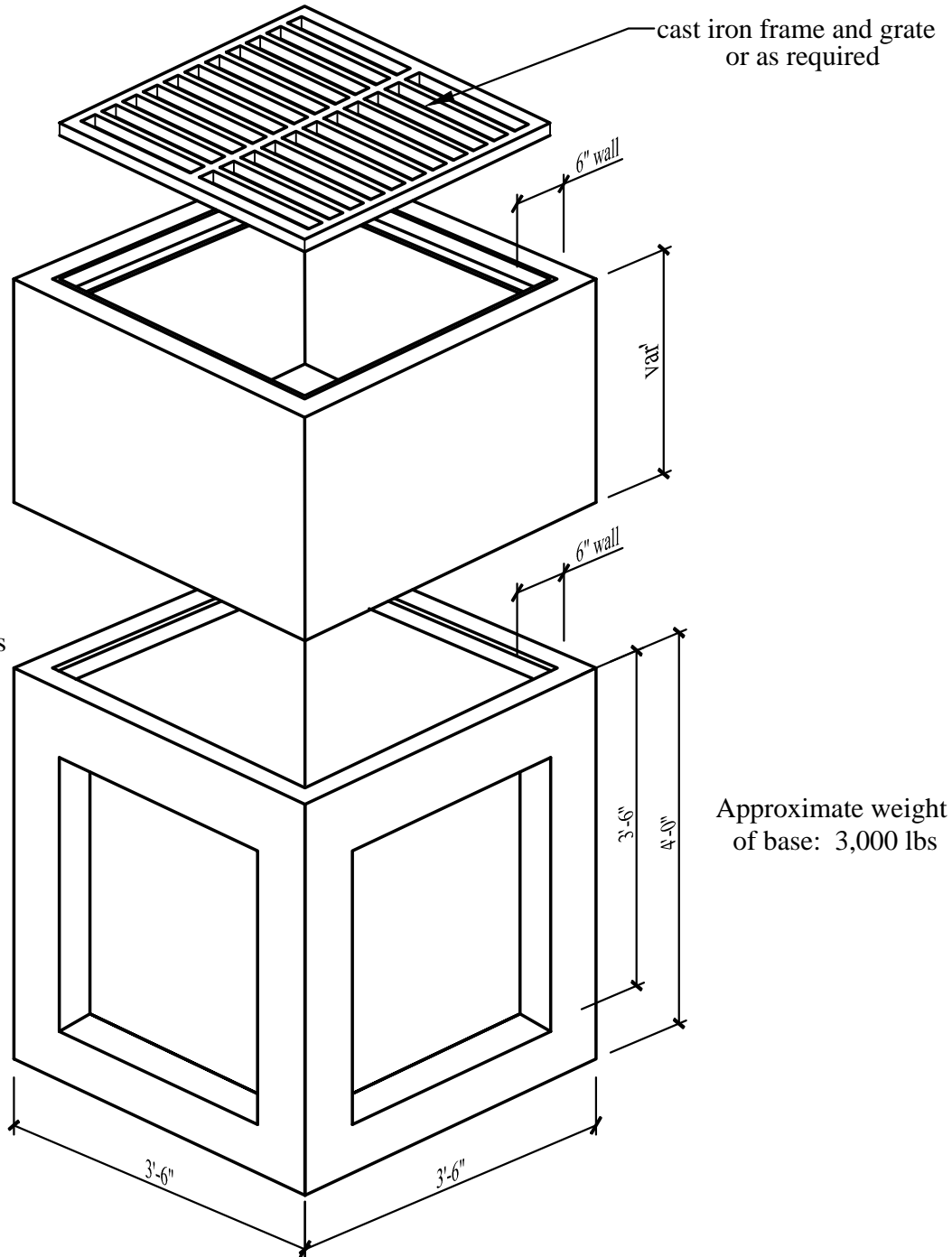

Bottom Section

30" x 30" thinwall knockouts
all four sides

Approximate weight
of base: 3,000 lbs

Specifications:

- Concrete has a 28 day strength of 5,000 psi
- Steel reinforcement is ASTM A615 grade 60
- Load design is H-20

Notes:

- Consult manufacturer before handling



CAPITAL PRECAST, INC.

6905 SOUTH OLD BASTROP HWY
SAN MARCOS, TEXAS 78666
PH. (830) 606-6200

FOR 30" x 30" x var Grate Inlet

JOB

DRAWN RW

DATE 12/1/2015

Rev. No.

SHEET

FILE

catalog/grate inlets/30x30 Grate Inlet

1 OF 1