

24" dia. Headwall (with dissipators)

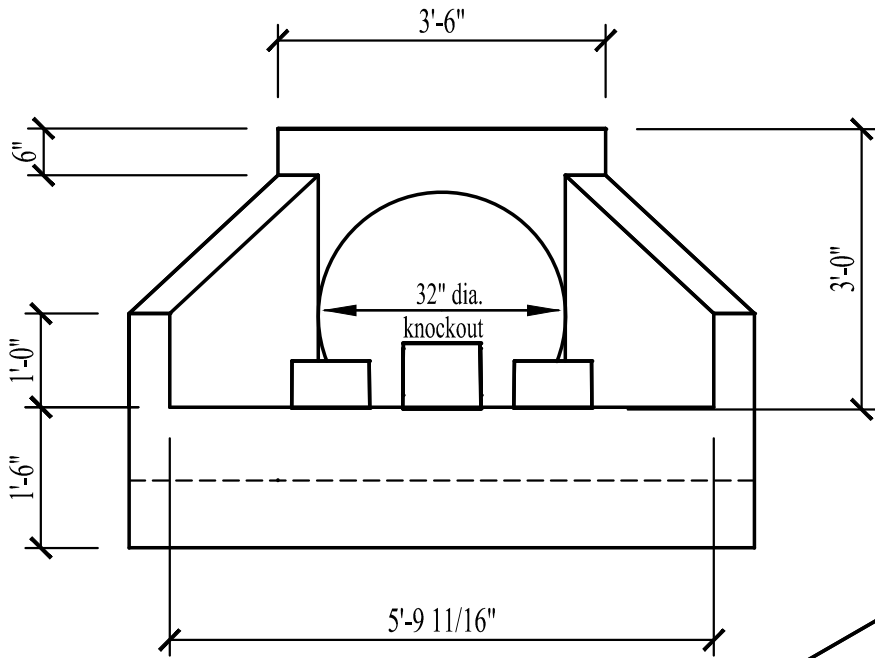

Approximate weight of product: 4,000 lbs

Concrete and steel specifications designed to meet Texas Highway Department standards

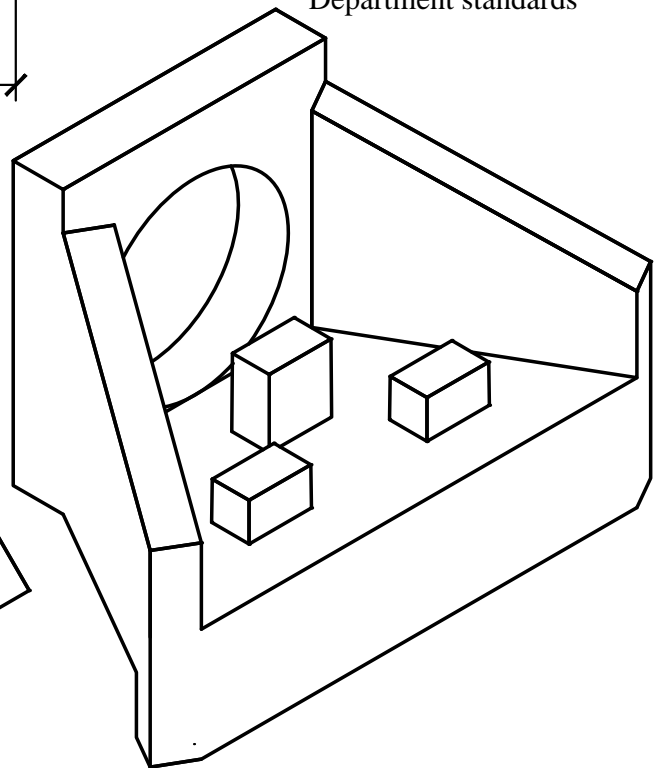
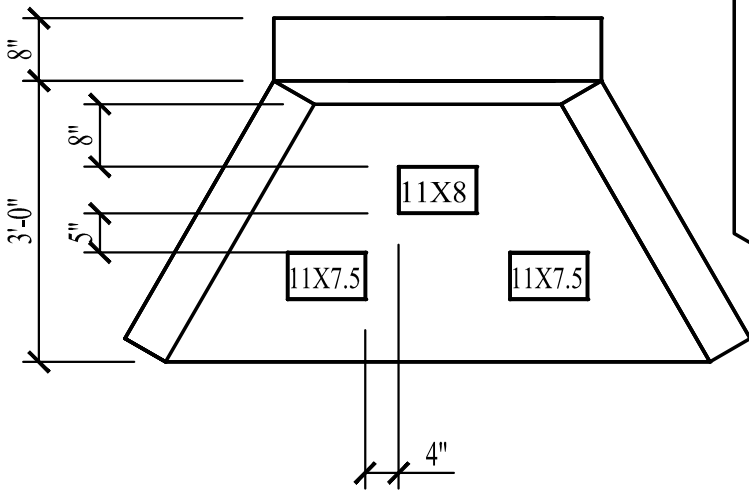

Specifications:

- Concrete has a 28 day strength of 5,000 psi
- Steel reinforcement is ASTM A615 grade 60
- All edges chamfered 3/4"

Notes:

- Consult manufacturer before handling



CAPITAL PRECAST, INC.

6905 SOUTH OLD BASTROP HWY
SAN MARCOS, TEXAS 78666
PH. (830) 606-6200

FOR 24" Headwall

JOB

DRAWN

RW

DATE

12/1/2015

Rev. No.

SHEET

FILE

catalog/headwalls/24 Headwall

1 of 1